

Metal Craft[®] **DOCKS & LIFTS**

The World's Most Durable Boat Piers!

Configuration Guide Floating Docks

January 1, 2006

Light Weight Floating Aluminum Docks

Heavy Duty Floating Aluminum Docks

Dock Accessories

The highest grade 6061/6063 aluminum marine alloys & 18-8 stainless fasteners are used.

Metal Craft **DOCKS**[®] are warranted for **15 years!**

(see Warranty for details)

Dealer Information and Orders: **800.989.DOCK**

Phone: 440.286.7135 FAX: 440.286.7134

Email: info@metalcraftdocks.com

www.metalcraftdocks.com

www.metalcraftlifts.com

Metal Craft Docks Inc.

300 Industrial Parkway
Chardon, Ohio 44024-1044

LIGHT WEIGHT and HEAVY DUTY FLOATING ALUMINUM BOAT DOCKS

Light Weight System - Strong Design. For Protected Waters, Homes, Camps, Cottages & Homeowner Associations. Handles Pontoons, Small and Medium Sized Boats.

Light Weight Floating docks are preferred over stationary/portable systems when water depths are greater than 10 ft. and/or water levels vary more than ± 1 ft. during boating season.

Heavy Duty System - Designed for Medium to Large Sized Boats, Semi-Protected Waters, Yacht Clubs, Marinas, Homeowners, Homeowner Associations, and Public Launch Facilities.

Heavy Duty Floating docks are preferred over Light Weight Floating systems when water or wind conditions are more severe, boats are larger/heavier, or, harsh use is expected.

General configuration guidelines

- Water depths at the dock site should be known (measured from lake bottom to top of water at normal allow pad or auger to reach the lake bottom structure).
- Lay out general shape of dock system to fit need.
 - The **14" Freeboard Light Weight Floating** models utilize the 4"H Deck structure and extra thick Side Rails. Ideal for inland waters and light boats up to 25 ft. long.
 - The **12" Freeboard Heavy Duty Floating** models have an 12"H Structural Box Frame. They are preferred for heavy use applications and heavy boats up to 25 ft. long.
 - The **22" Freeboard Heavy Duty Floating** models have an 8"H Structural Box Frame. They are preferred for pontoon boats and heavy boats 18 ft. to 27 ft.
 - The **26" Freeboard Heavy Duty Floating** models have an 12"H Structural Box Frame. They are preferred for heavy boats 25 ft. long and up.
- If a **Semi-Floating Ramp** is utilized, use a hinged **Shoreline Mounting Connection, Floating** at the shore and a **Hinged Connection** at the intersection with the first full floating section.
- If the **Semi-Floating Ramp** is to be hinged off a seawall, use the **Tee Hinge Connection**. The Tee Hinges are mounted on the seawall and Male Hinges are used on the Ramp.
- If lake conditions are generally calm water, use all **Locking Connections** for connecting the **Full Floating Sections** together.
- If lake conditions are not calm, hinge sections where structural stresses would occur if locked together. Use a combination of **Hinged Connection** and **Locking Connections** for connecting the **Full Floating Sections** together. At the extreme, severe lake conditions may require a fully hinged system.
- Use **Hinged and Locked Connection Braces** (pair) to connect finger docks at 90° angle on the **Light Weight Floating** system.

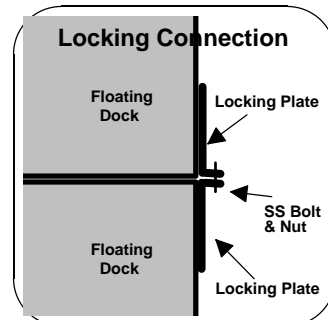
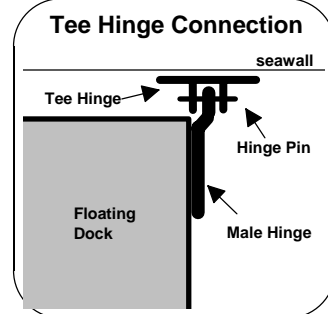
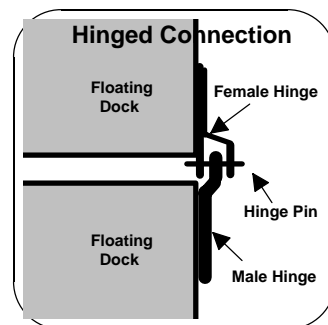
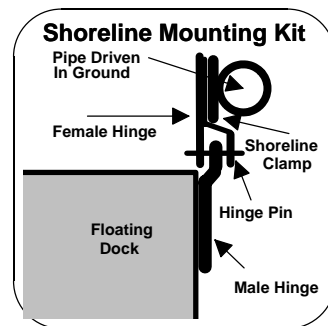

CONFIGURATION SUGGESTIONS, Continued

- Long finger docks and heavy boats require the use of **Finger Gussets** and/or Spud Piles on the end of the finger. Reinforcement angles are included that run under the deck of the walkway and finger to connect to the 45° brace.
 - ◆ The **Finger Gussets** can be either **Locked** or **Hinged**, to match the method of finger attachment.
 - ◆ Use a **1-Way Finger Gusset** to strengthen a corner type connection.
 - ◆ Use a **2-Way Finger Gusset** to strengthen one finger dock.
 - ◆ Use a **4-Way Finger Gusset** to strengthen two finger docks.
- **Aluminum Auger Spud Pipes** used with the **3"ID Steel Ring Collar** provide easily removed spud piles for locations (up to 7' ft. water depth) where the piles and docks have to be relocated during the boating season, or, have to be taken out for winter.
- Sch 40 galvanized steel spud pipes (not supplied by Metal Craft) should be used in water depths over 7', and, where wave conditions may cause excessive wear of aluminum spud pipes. These can be either driven or augered into position.
- **Elongated Spud Holders** are used where the dock system is tied to shore with a Semi-Floating Ramp/Dock Section and water levels vary greater than ± 1.5 ft. The dock system moves in and out relative to shore as water levels vary -- the elongated holder provides clearance for the dock and spud pile to accommodate this movement.

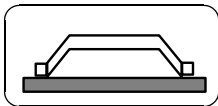
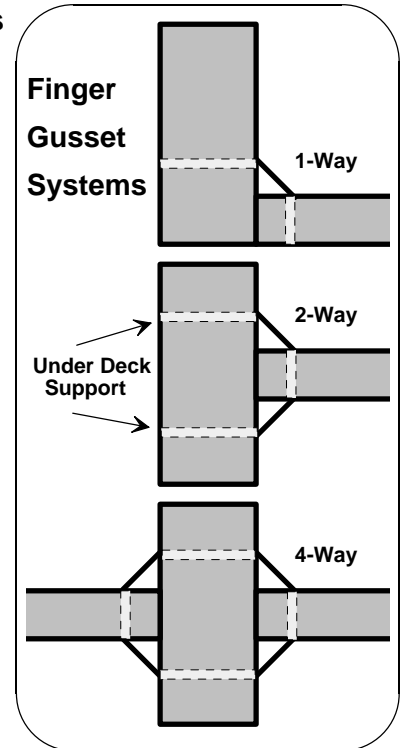

- **Handrails** can be added to Light Weight and Heavy Duty Floating Docks. See the Customer Price Book for more information.

A Complete Line of *Metal Craft* **DOCKS**[®] Matched Accessories is Available

Mooring Cleats
Swim & Dock Ladders
Horizontal Bumper Brackets
Vertical Bumper Brackets
Base Pads and Support Pipes
Auger Pipes & Clamps
Splayed Leg Extensions
Side and End Braces
Stairs
PWC Lifts - 850 & 1200 Models

White PVC Bumpers
Dock Benches
Access Ramps
Corner Half Braces
Shoreline Connection Kits
Trussed Handrails
Spud Pipe Holders
Hinge and Locking Connections
Finger Braces and Gussets
Vertical Lifts - 4000 & 5000 Models

Light Weight Floating #1

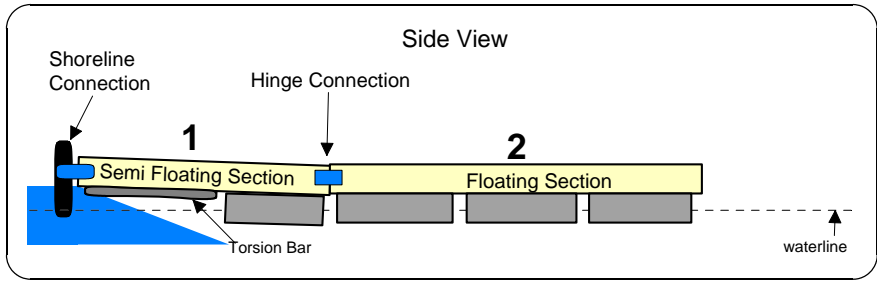
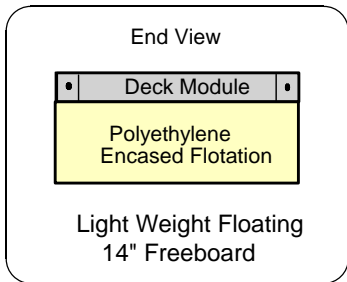
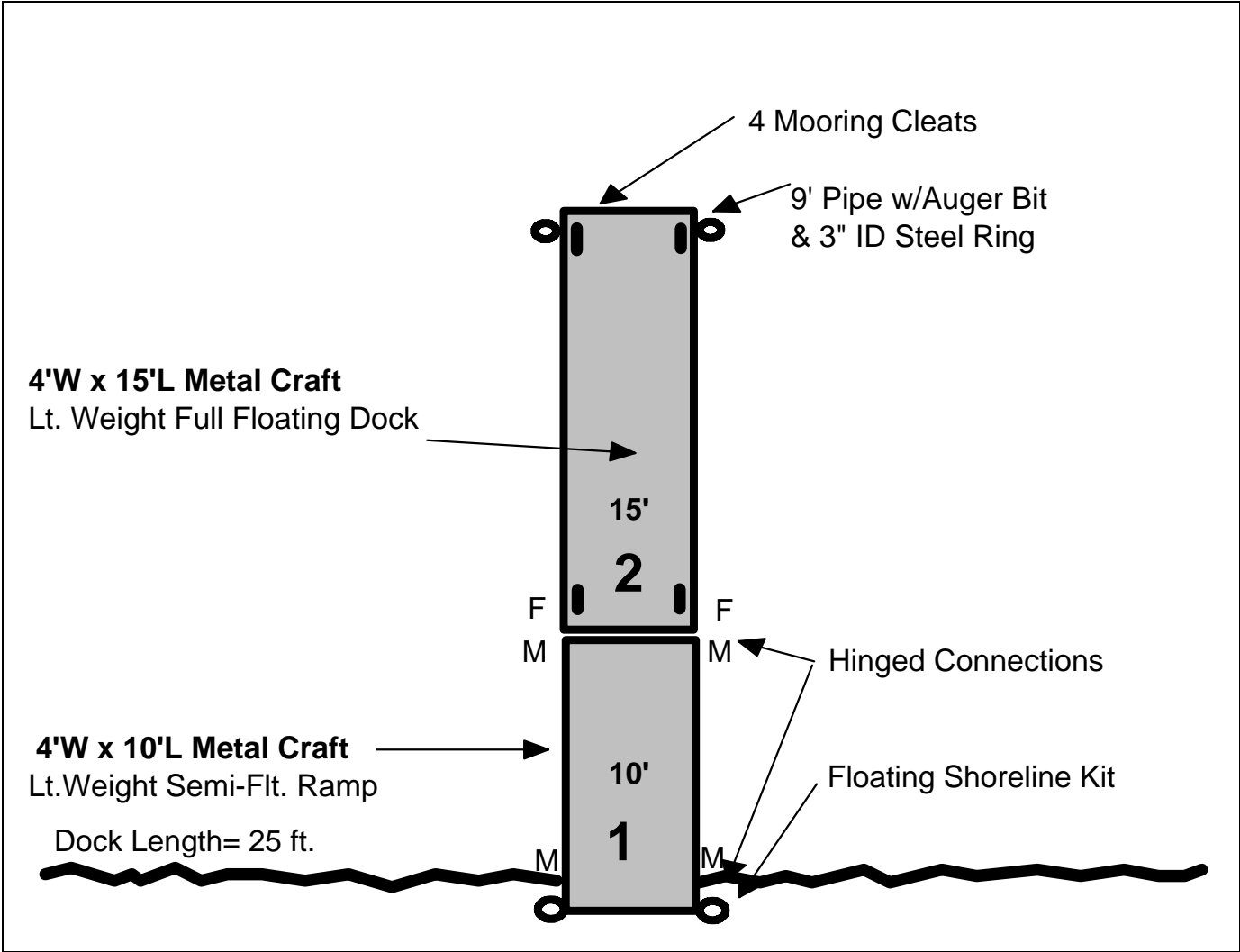

| Qty | Description | Qty | Description |
|-----|---|-----|---------------------------------|
| 1 | Shoreline Mounting Kit, H.Duty, 1 7/8" Pipe, Floating | 2 | 3" ID Steel Ring Collar |
| 1 | 4'W x 10'L Lt.Weight Semi-Floating Ramp w/Torsion Bar | 2 | 9'H Spud Pipe w/Auger Bit & Cap |
| 1 | H. Duty Hinge Connection, Complete | 4 | Mooring Cleat |
| 1 | 4'W x 15'L Lt. Weight Full Floating Dock | | |

Metal Craft's Light Weight Aluminum Floating Docks in three widths: 10', 12.5" & 15'; four widths: 3', 4', 5' & 6'; and three colors: Cloud White, Earth Sand and Sea Green.

Light Weight Floating #2

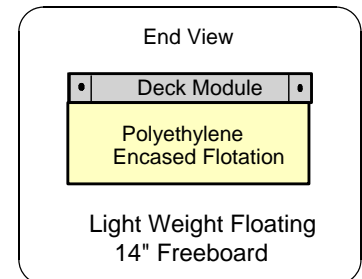
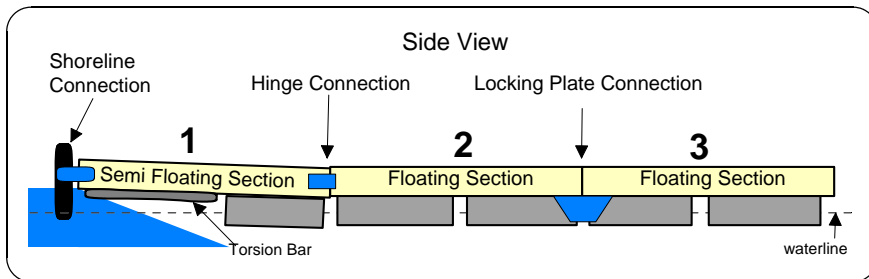
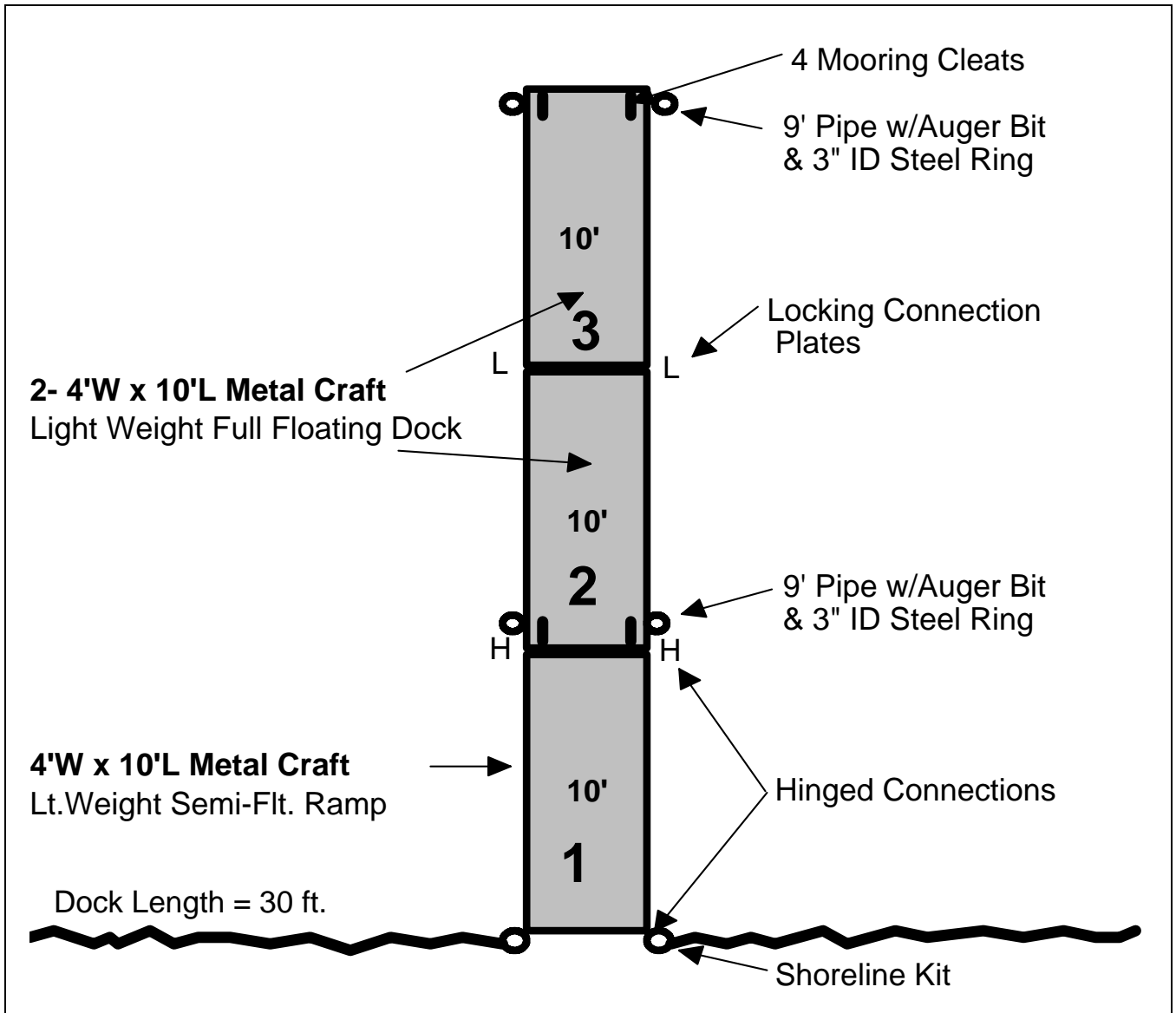

| Qty | Description | Qty | Description |
|-----|---|-----|---|
| 1 | Shoreline Mounting Kit, H.Duty, 1 7/8" Pipe, Floating | 1 | 14"H Locking Plate Connection, Complete |
| 1 | 4'W x 10'L Lt.Weight Semi-Floating Ramp w/Torsion Bar | 4 | 3" ID Steel Ring Collar |
| 1 | H. Duty Hinge Connection, Complete | 4 | 9'H Spud Pipe w/Auger Bit & Cap |
| 2 | 4'W x 10'L Lt. Weight Full Floating Dock | 4 | Mooring Cleat |

Light Weight Floating #3

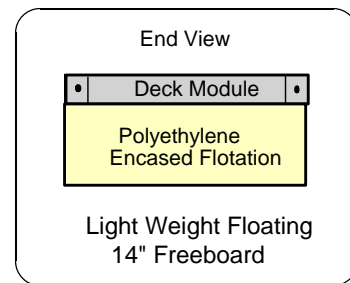
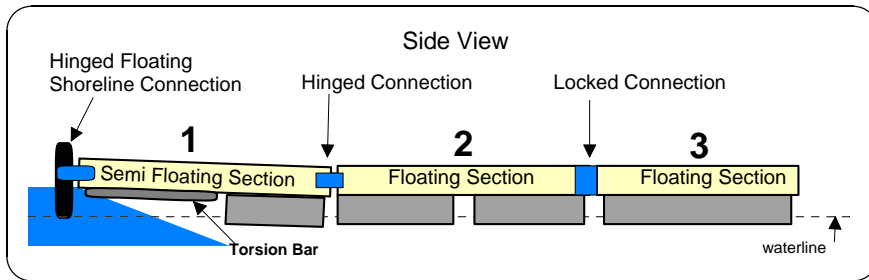
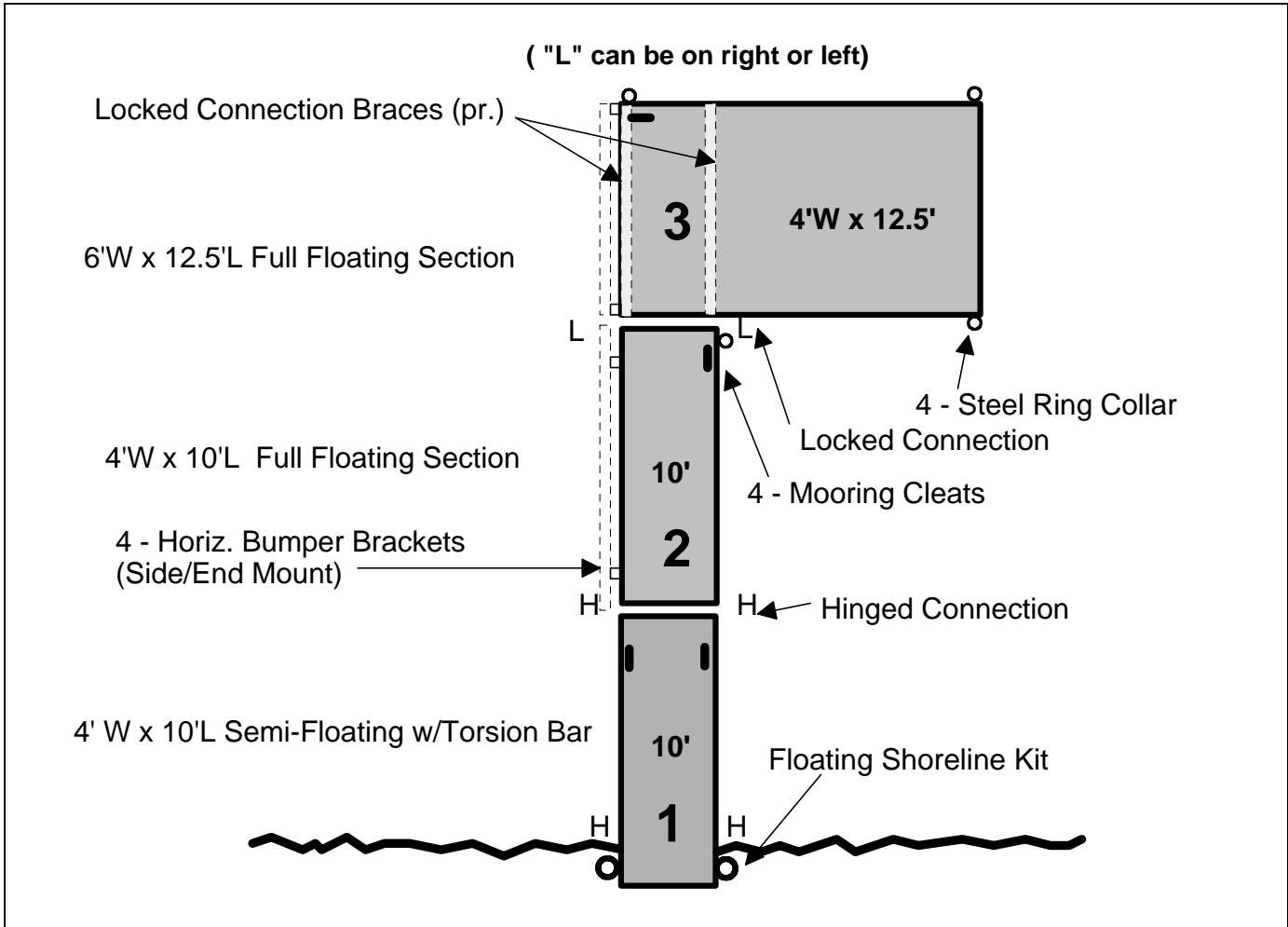

| Qty | Description | Qty | Description |
|-----|---|-----|--------------------------------------|
| 1 | Shoreline Mounting Kit, H.Duty, 1 7/8" Pipe, Floating | 1 | 14"H Locking Plate Connection, Left |
| 1 | 4'W x 10'L Lt.Weight Semi-Floating Ramp w/Torsion Bar | 1 | 14"H Locking Plate Connection, Right |
| 1 | H. Duty Hinge Connection, Complete | 1 | Locked Connection Brace (pr.) |
| 1 | 4'W x 10'L Lt. Weight Full Floating Dock | 4 | 3" ID Steel Ring Collar |
| 1 | 6'W x 12.5'L Lt. Weight Full Floating Dock | 3 | 9'H Spud Pipe w/Auger Bit & Cap |
| 4 | Horizontal Bumper Bracket, Side/End Mount | 4 | Mooring Cleat |

Light Weight Floating #4

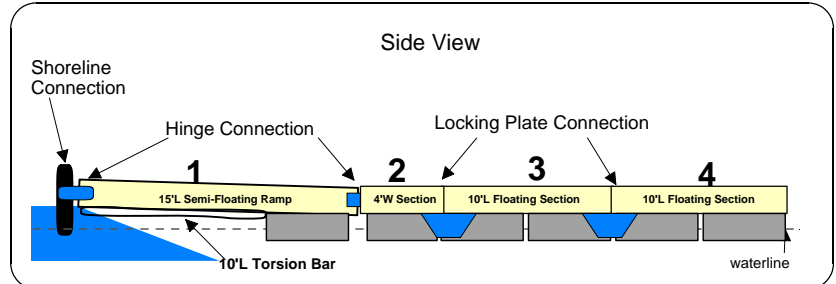
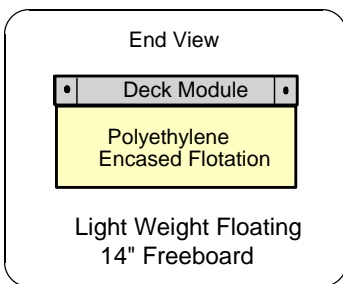
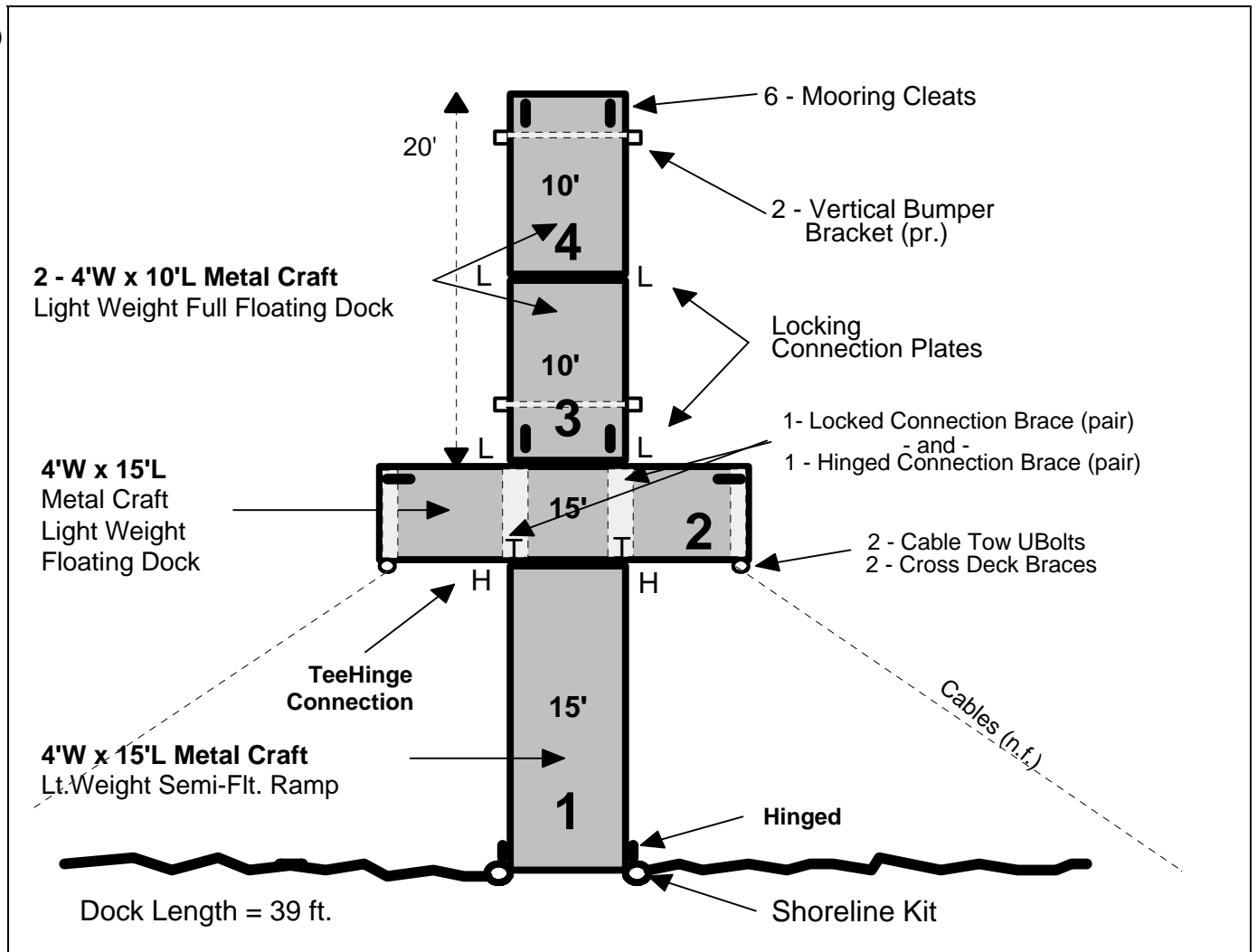

| Qty | Description | Qty | Description |
|-----|--|-----|--|
| 1 | Shoreline Mounting Kit, H.Duty, 1 7/8" Pipe, Floating | 2 | Cable Tow U-Bolt, Stainless |
| 1 | 4'W x 15'L Lt. Weight Semi-Floating Ramp w/Torsion Bar | 2 | 4'W x 10'L Lt. Weight Full Floating Dock |
| 1 | H. Duty Tee Hinge Connection, Complete | 3 | 14"H Locking Plate Connection, Left |
| 1 | 4'W x 15'L Lt. Weight Full Floating Dock | 3 | 14"H Locking Plate Connection, Right |
| 1 | Locked Connection Braces (pair) | 2 | Vertical Bumper Bracket, Side Mount (pair) |
| 1 | Hinged Connection Braces (pair) | 6 | Mooring Cleat |
| 2 | Cross Deck Brace (reinforcement for U-Bolts) | 2 | White PVC Boat Bumper, 10'L |

Light Weight Floating #5

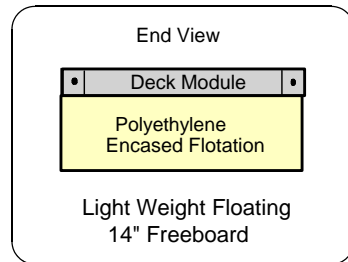
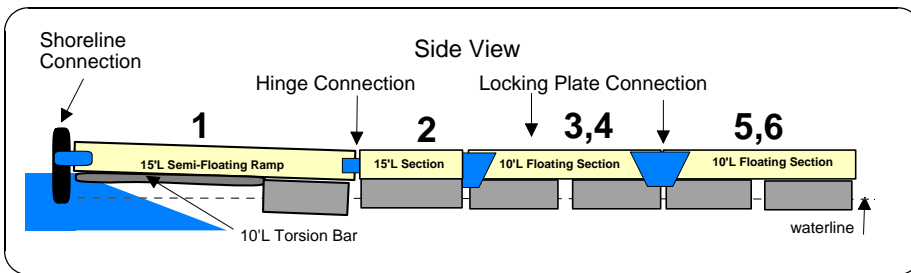
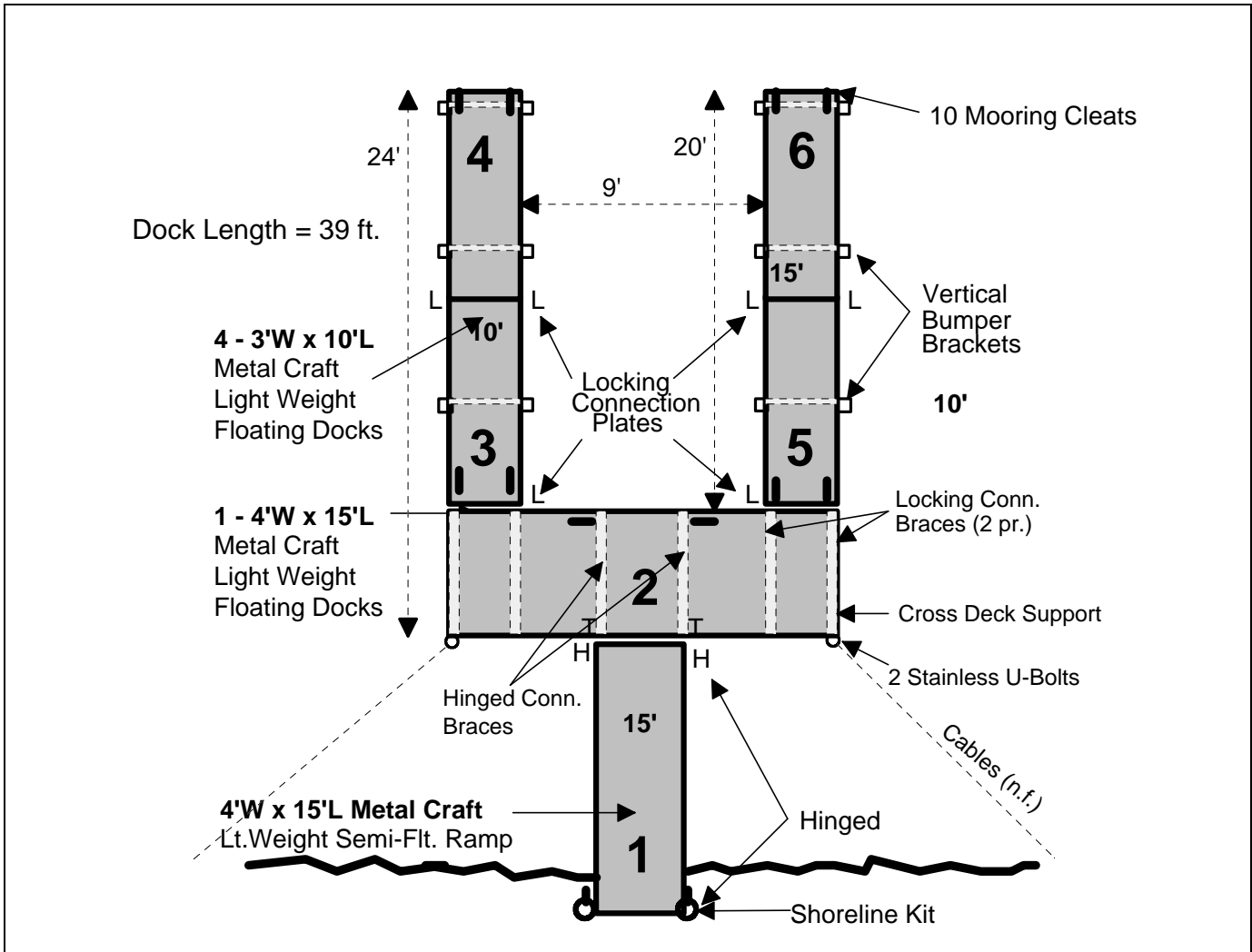

| Qty | Description | Qty | Description |
|-----|--|-----|---|
| 1 | Shoreline Mounting Kit, H.Duty, 1 7/8" Pipe, Floating | 4 | 3'W x 10'L Lt. Weight Full Floating Dock |
| 1 | 4'W x 15'L Lt. Weight Semi-Floating Ramp w/Torsion Bar | 6 | 14"H Locking Plate Connection, Left |
| 1 | H. Duty Tee Hinge Connection, Complete | 6 | 14"H Locking Plate Connection, Right |
| 1 | 4'W x 15'L Lt. Weight Full Floating Dock | 6 | Vertical Bumper Bracket, Side Mount, Pair |
| 2 | Locked Connection Braces (pair) | 2 | 4'WCross Deck Support (reinforce U-Bolts) |
| 1 | Hinged Connection Braces (pair) | 10 | Mooring Cleat |
| 2 | Cable Tow U-Bolt, Stainless | 3 | White PVC Boat Bumper, 10'L |

Note: Large boats and/or heavy wave action may require 45° 1-Way Corner Gussets.

Light Weight Floating #6

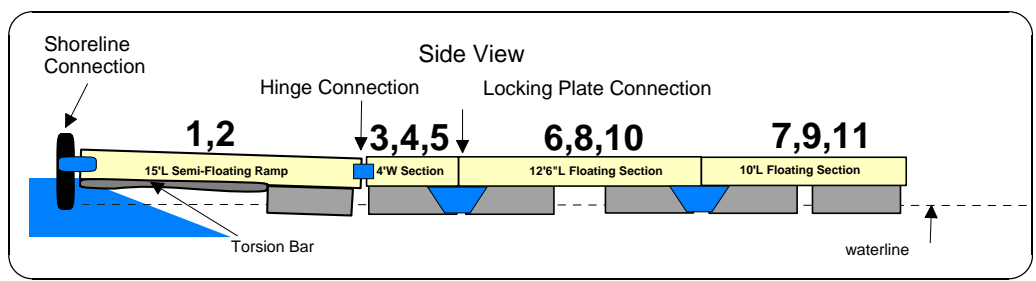
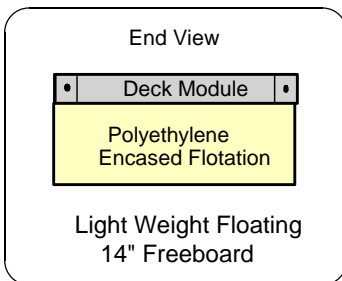
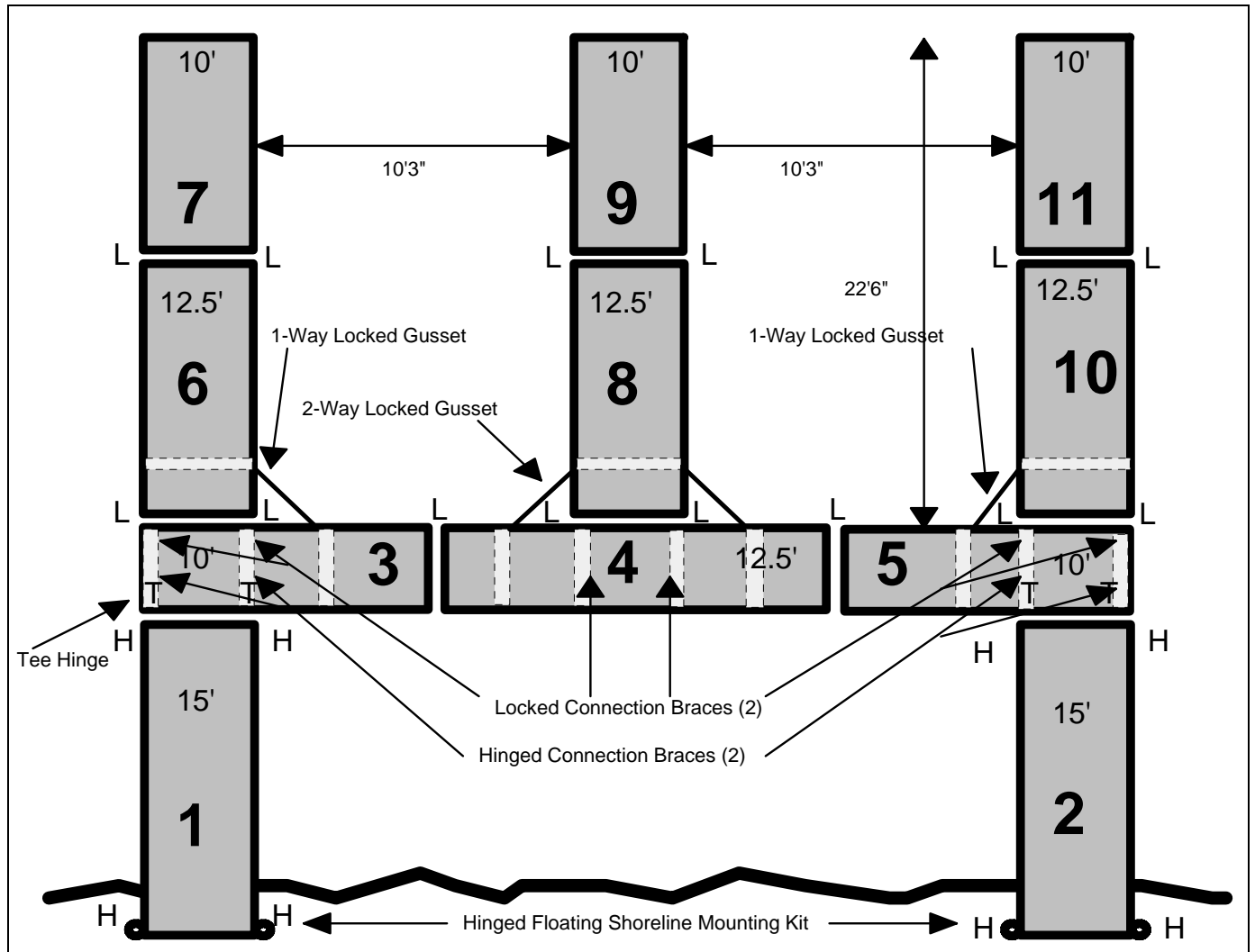

| Qty | Description | Qty | Description |
|-----|---|-----|--|
| 2 | Shoreline Mounting Kit, H.Duty, 1 7/8" Pipe, Floating | 4 | 4'W x 12.5'L Lt. Weight Full Floating Dock |
| 2 | 4'W x 15'L Lt.Weight Semi-Floating Ramp w/Torsion Bar | 13 | 14"H Locking Plate Connection, Left |
| 2 | H. Duty Tee Hinge Connection, Complete | 13 | 14"H Locking Plate Connection, Right |
| 5 | 4'W x 10'L Lt. Weight Full Floating Dock | 2 | 1-Way Locked Gusset System |
| 3 | Locked Connection Braces (pair) | 1 | 2-Way Locked Gusset System |
| 2 | Hinged Connection Braces (pair) | | |

Light Weight Floating #7

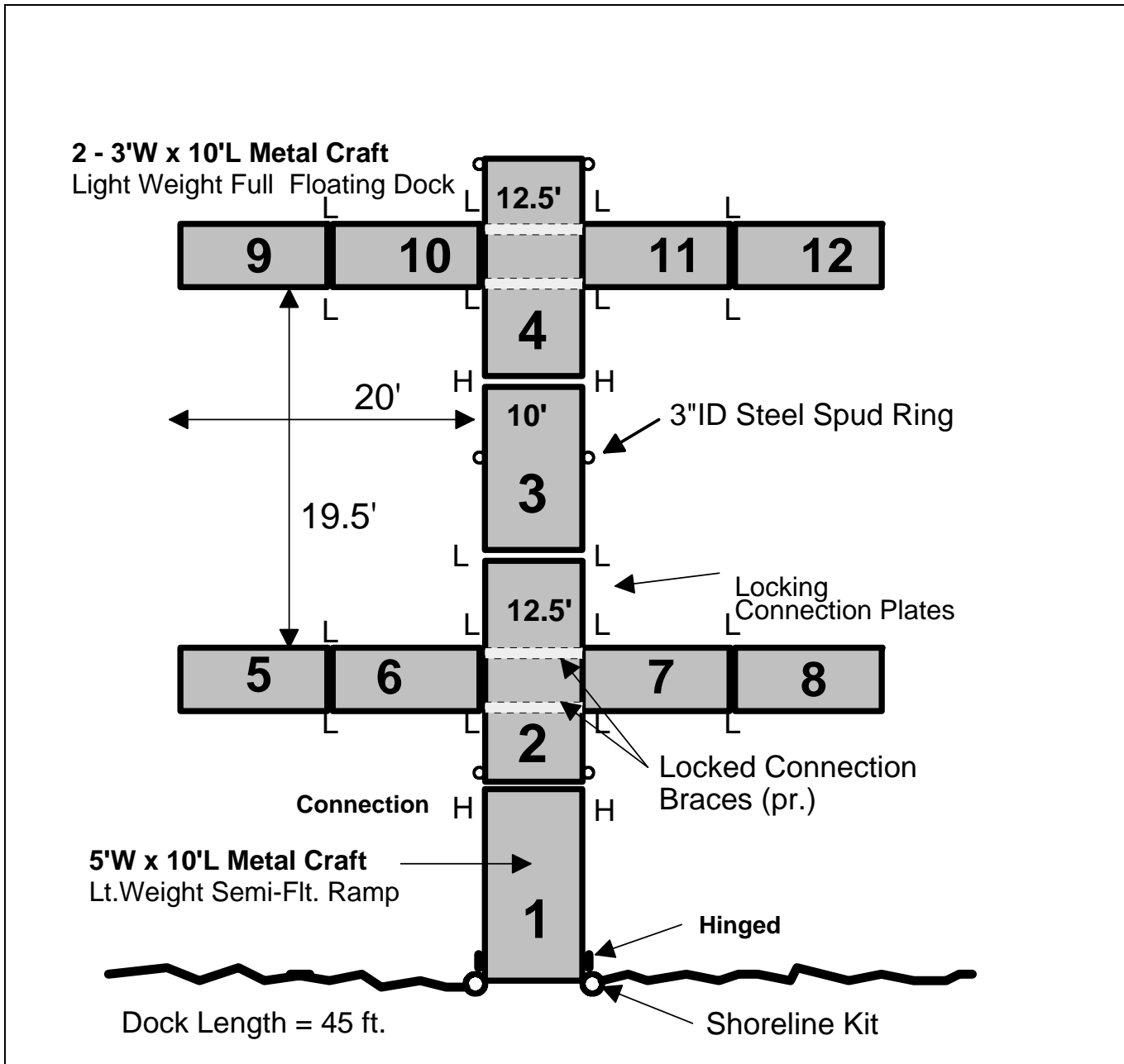

| Qty | Description | Qty | Description |
|-----|---|-----|---|
| 1 | Shoreline Mounting Kit, H.Duty, 1 7/8" Pipe, Floating | 2 | Locked Connection Braces (pair) |
| 1 | 5'W x 10'L Lt.Weight Semi-Floating Ramp w/Torsion Bar | 14 | 14"H Locking Plate Connection, Left |
| 1 | 5'W x 10'L Lt.Weight Full Floating Dock | 14 | 14"H Locking Plate Connection, Right |
| 2 | 5'W x 12.5'L Lt.Weight Full Floating Dock | 16 | Mooring Cleat (2/slip) |
| 8 | 3'W x 10'L Lt.Weight Full Floating Dock | 6 | 3" ID Steel Spud Ring (minimum - more if rough water) |
| 2 | H. Duty Hinge Connection, Complete | 6 | 2" ID Steel Pipe (<i>by others; minimum qty.</i>) |

Light Weight Floating #8

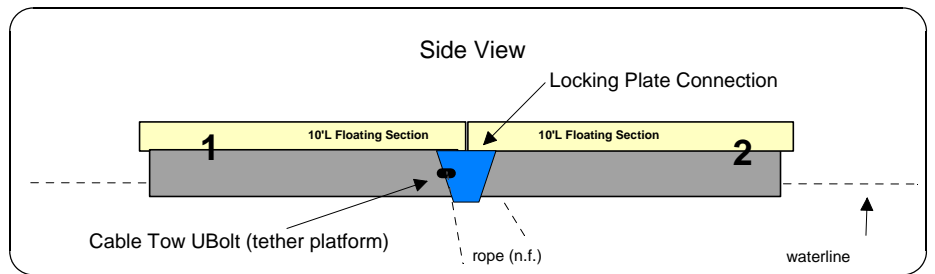
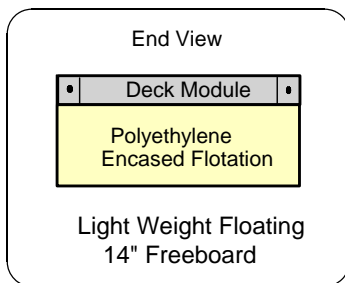
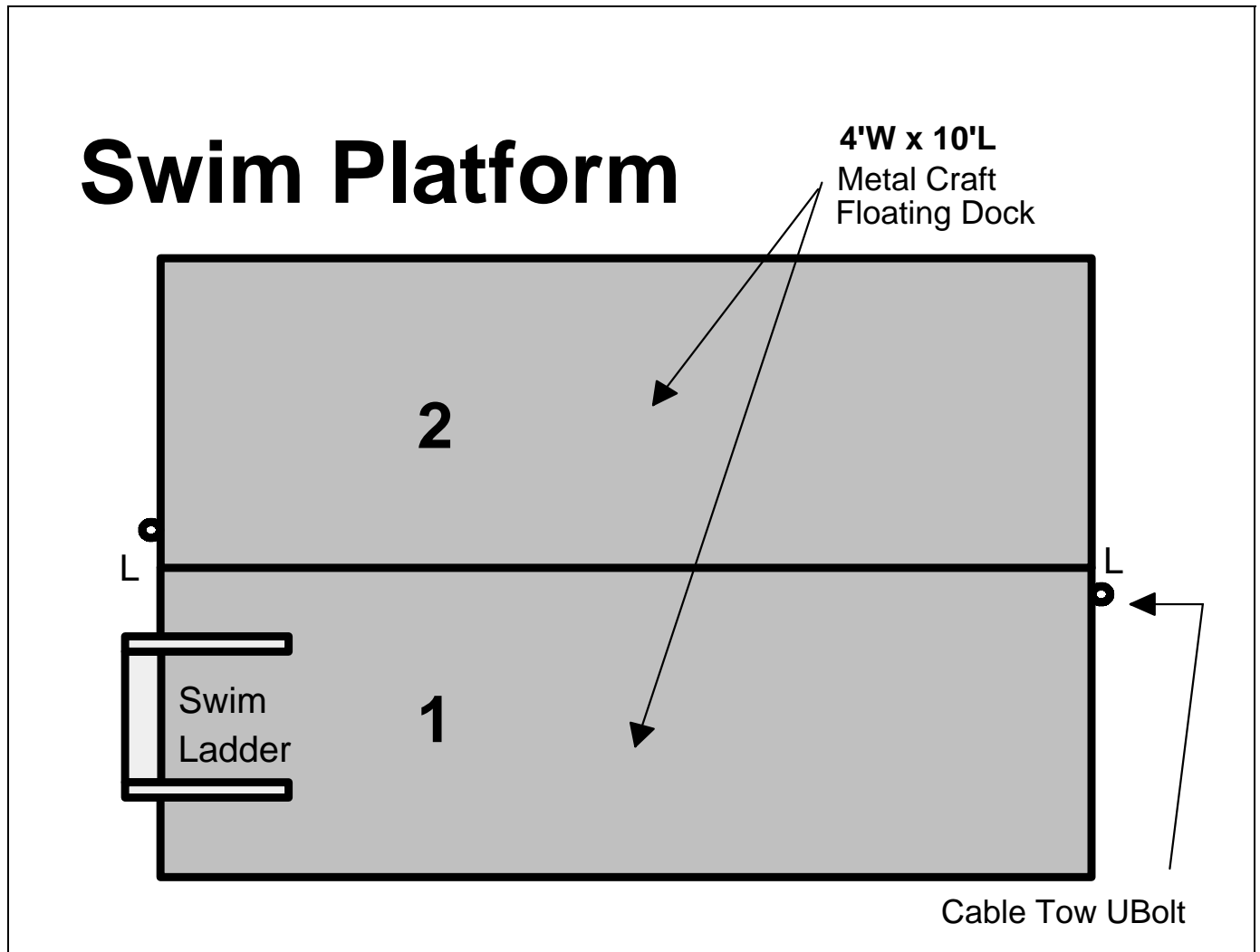

| Qty | Description | Qty | Description |
|-----|--|-----|-----------------------------|
| 2 | 4'W x 10'L Lt. Weight Full Floating Dock | 2 | Cable Tow U-Bolt, Stainless |
| 2 | 14"H Locking Plate Connection, Left | 1 | 4-Step Aluminum Swim Ladder |
| 2 | 14"H Locking Plate Connection, Right | | |

More Light Weight Floating Dock Examples

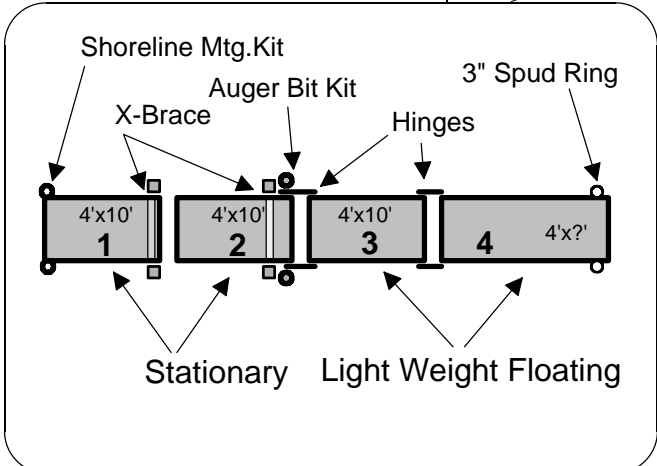
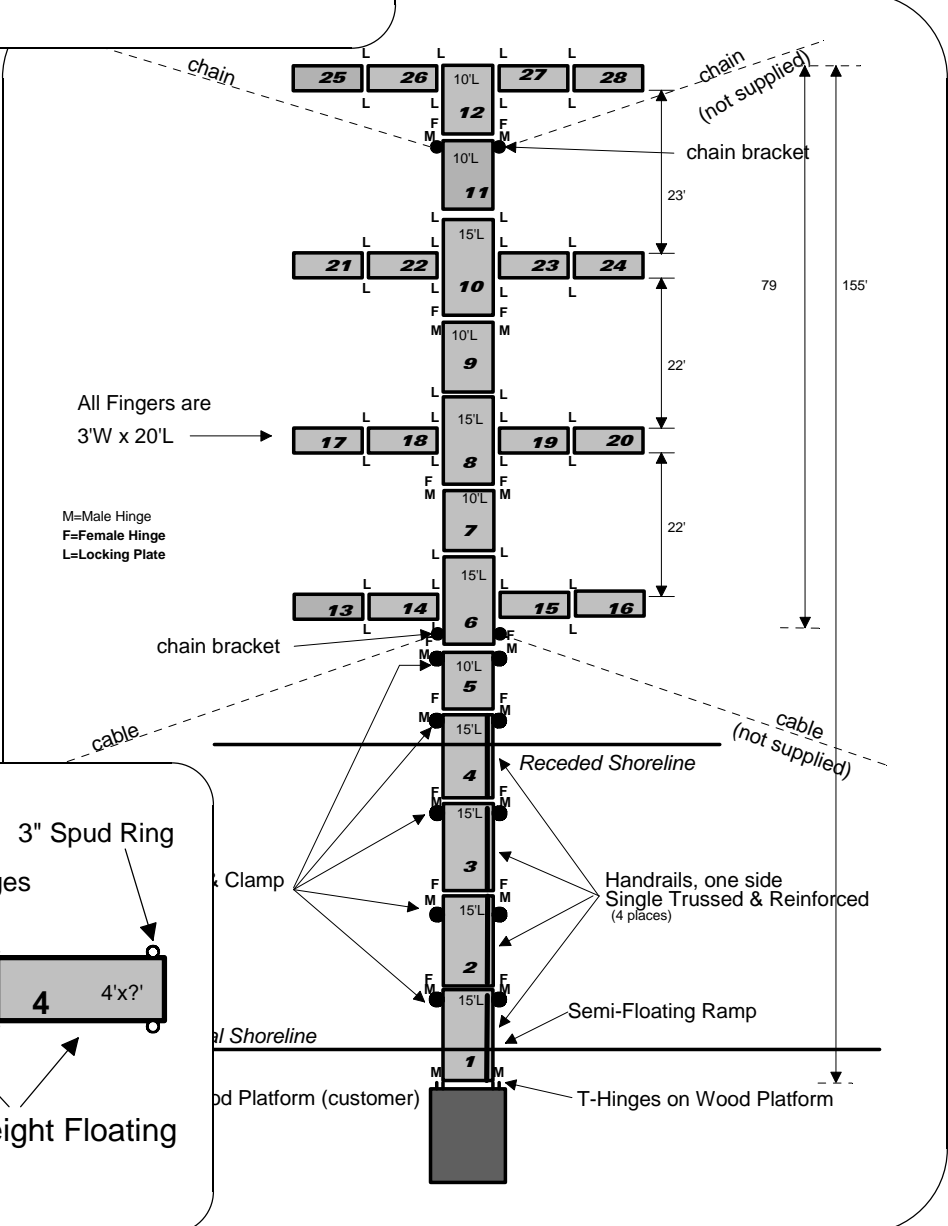
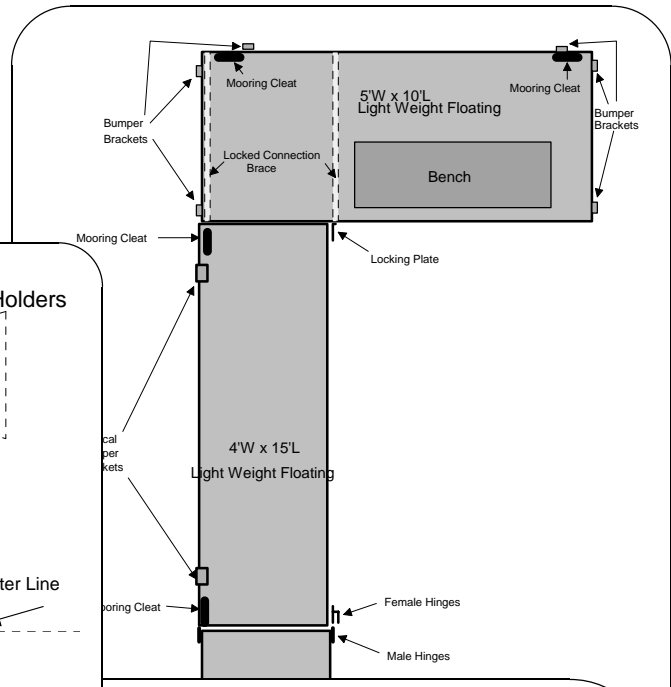
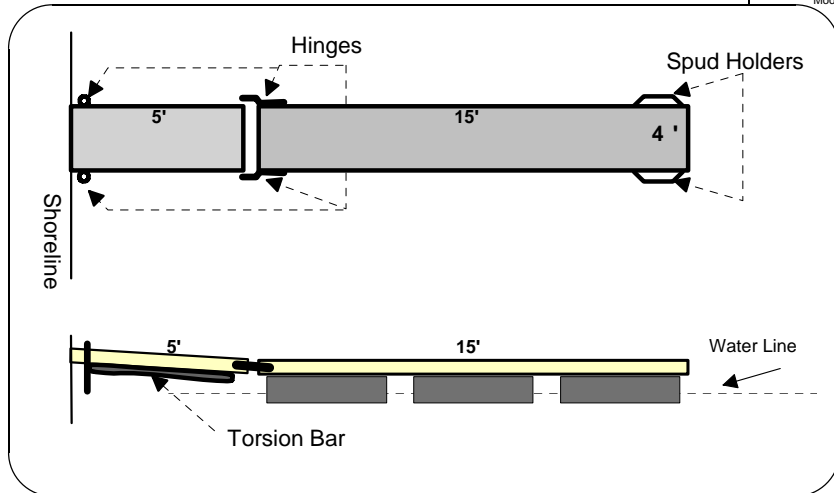

Heavy Duty Floating #1

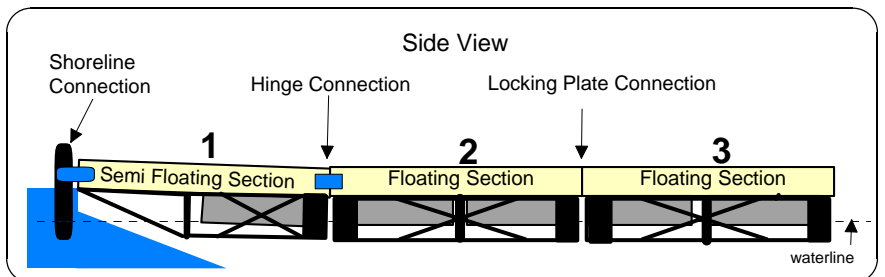
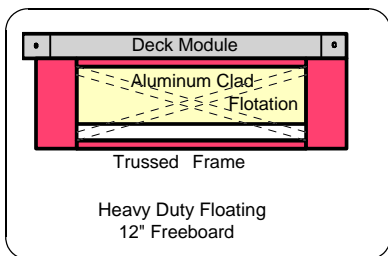
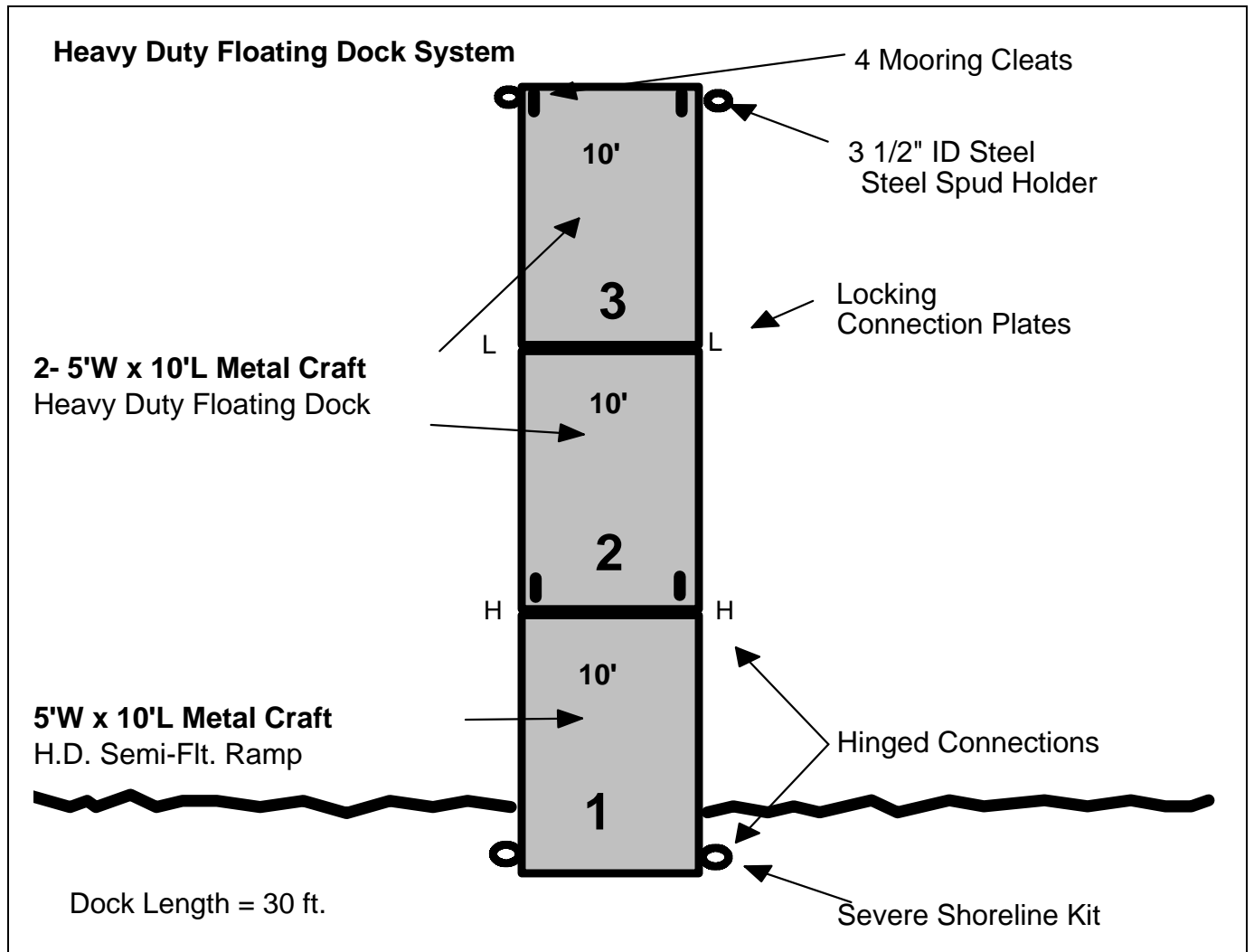

| Qty | Description | Qty | Description |
|-----|---|-----|--------------------------------------|
| 1 | Shoreline Mounting Kit, S.Duty, 2 7/8" Pipe, Floating | 1 | H. Duty Locking Connection, Complete |
| 1 | 5'W x 15'L H. Duty Semi-Floating Ramp, 12" FB | 2 | 3 1/2" ID x 12"H Steel Spud Holder |
| 2 | 5'W x 10'L H. Duty Full Floating Dock, 12" FB | 4 | Mooring Cleat |
| 1 | H. Duty Hinge Connection, Complete | | |

Metal Craft's Heavy Duty Floating Docks come in three lengths: 10', 12.5' & 15"; four widths: 3', 4', 5' & 6', and three colors: Cloud White, Earth Sand and Sea Green.

Heavy Duty Floating #2

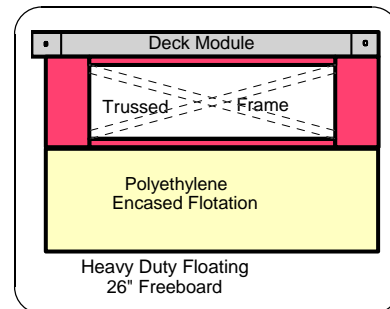
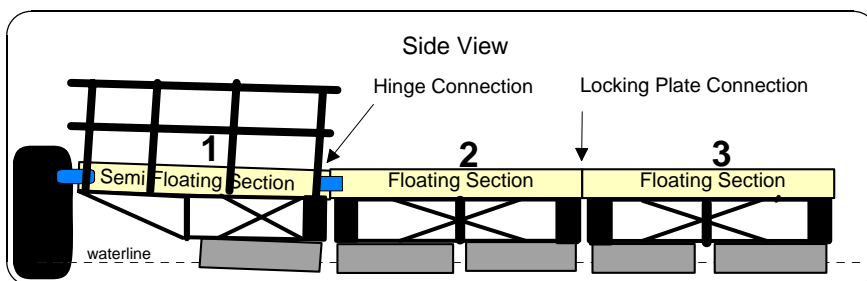
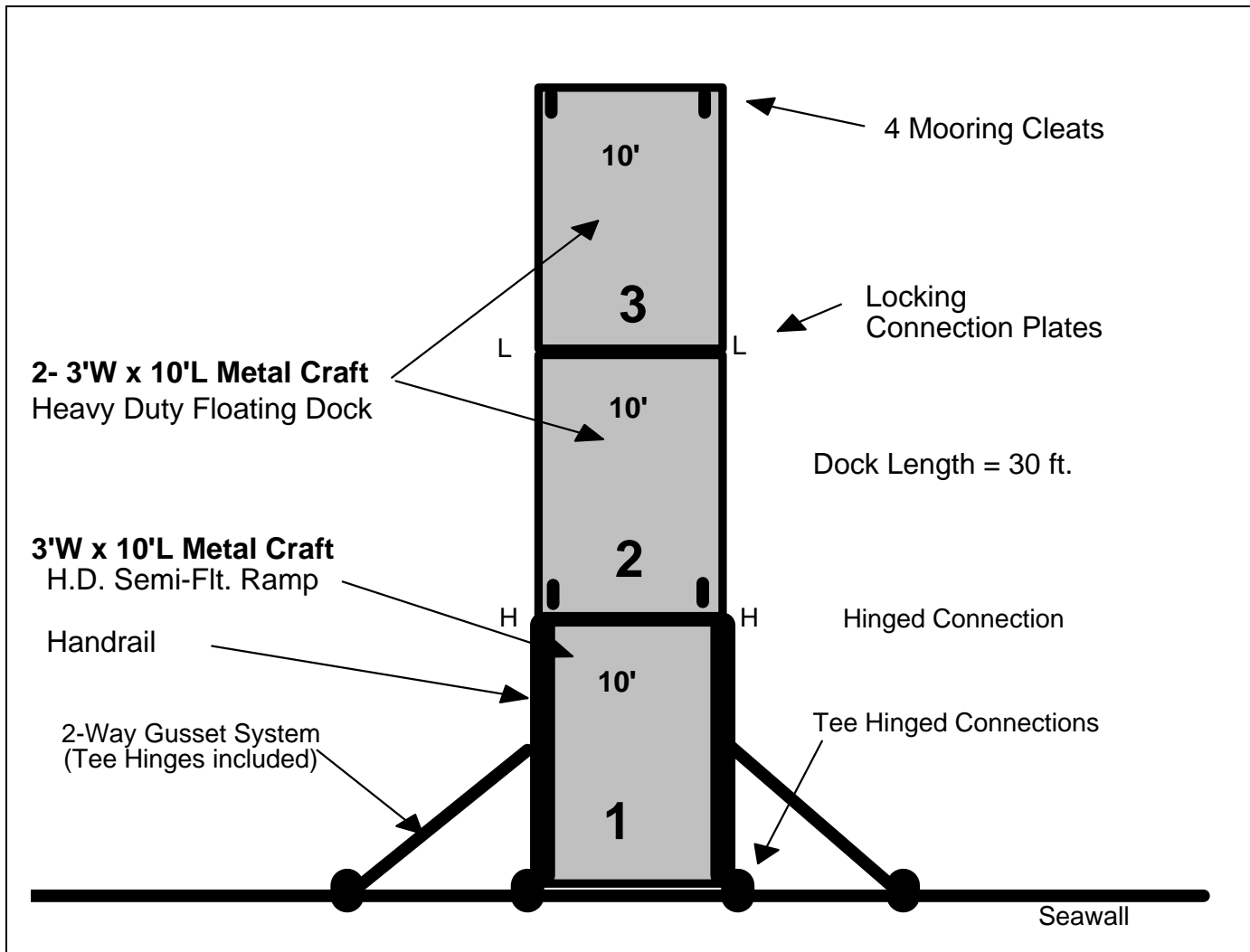

| Qty | Description | Qty | Description |
|-----|---|-----|---|
| 1 | H. Duty Tee Hinge Connection | 1 | 2-Way Gusset System, Hinged |
| 1 | 3'W x 10'L H. Duty Semi-Floating Ramp, 26" FB | 4 | Mooring Cleat |
| 2 | 3'W x 10'L H. Duty Full Floating Dock, 26" FB | 20 | Non-Trussed or Single Trussed Handrail |
| 1 | H. Duty Hinge Connection, Complete | 8 | Vertical Bumper Brackets <i>(optional)</i> |
| 1 | H. Duty Locking Connection, Complete | 3 | White PVC Boat Bumper, 10'L <i>(optional)</i> |

Heavy Boats and/or severe wave action will require addition of custom elongated spud holder on end of dock.

Heavy Duty Floating #3

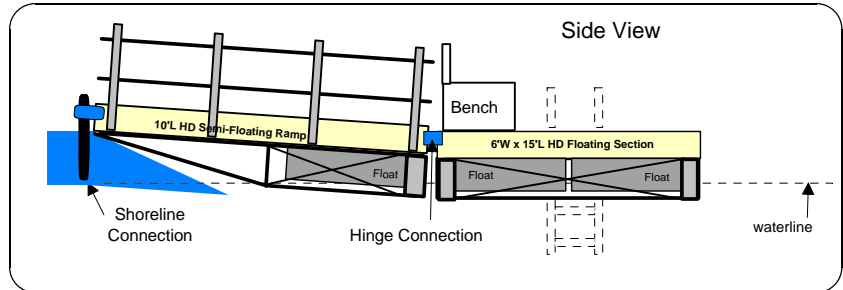
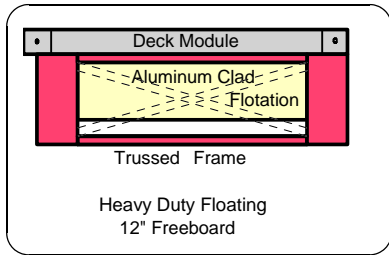
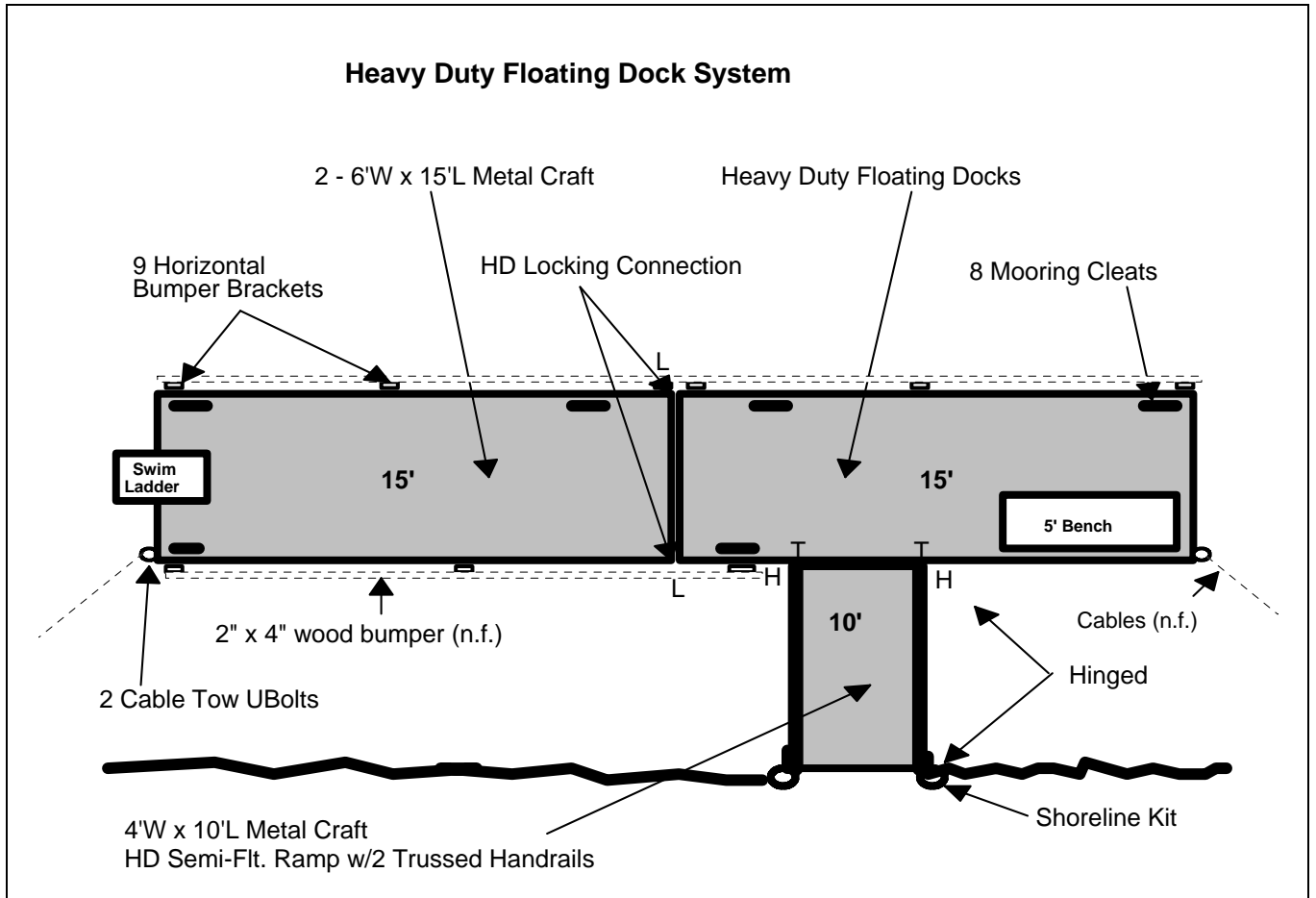

| Qty | Description | Qty | Description |
|-----|---|-----|-----------------------------|
| 1 | Shoreline Mounting Kit, H.Duty, 1 7/8" Pipe, Floating | 2 | Cable Tow U-Bolt, Stainless |
| 1 | 4'W x 10'L H. Duty Semi-Floating Ramp, 12" FB | 9 | Horizontal Bumper Bracket |
| 20 | Non-Trussed or Single Trussed Handrail | 5 | White PVC Boat Bumper, 10'L |
| 1 | H. Duty Tee Hinge Connection, Complete | 6 | Mooring Cleat |
| 2 | 6'W x 15'L H. Duty Full Floating Dock, 12" FB | 1 | 4-Step Aluminum Ladder |
| 1 | H. Duty Locking Connection, Complete | 1 | 3-Person Aluminum Bench |

More Heavy Duty Floating Dock Examples

Dock Association

(Not to Scale)

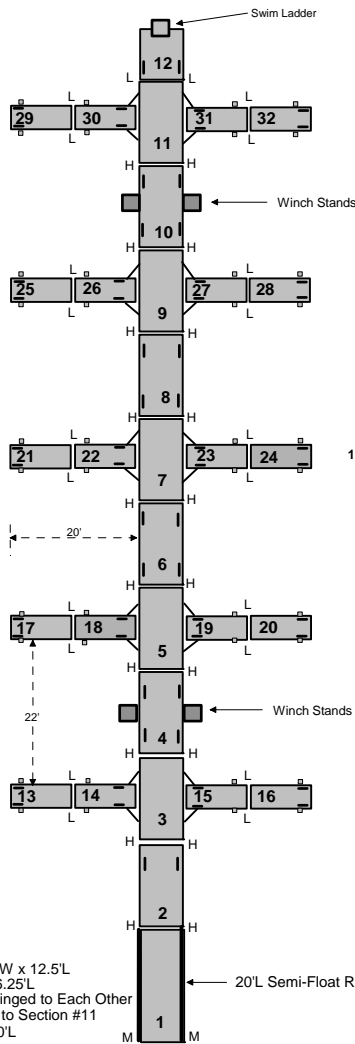

Notes:

- Walkway Sections #2-#11 are 5'W x 12.5'L
- Walkway Section #12 is 5'W x 6.25'L
- Walkway Sections #2-#11 are Hinged to Each Other
- Walkway Section #12 is Locked to Section #11
- All Finger Sections are 3' W x 10'L
- All Fingers are 20' Long
- All Fingers are Hinged to the Walkway
- All Finger Sections are Locked Together
- All Hinge Connections are on the Frame
- 2 Vertical Bumper Brackets per Slip
- 20' Ramp has Handrails on Both Sides
- Handrails are Single Trussed
- 3 Mooring Cleats per Slip

